

Perfect Door

CATALOGUE
EDITION I 2023

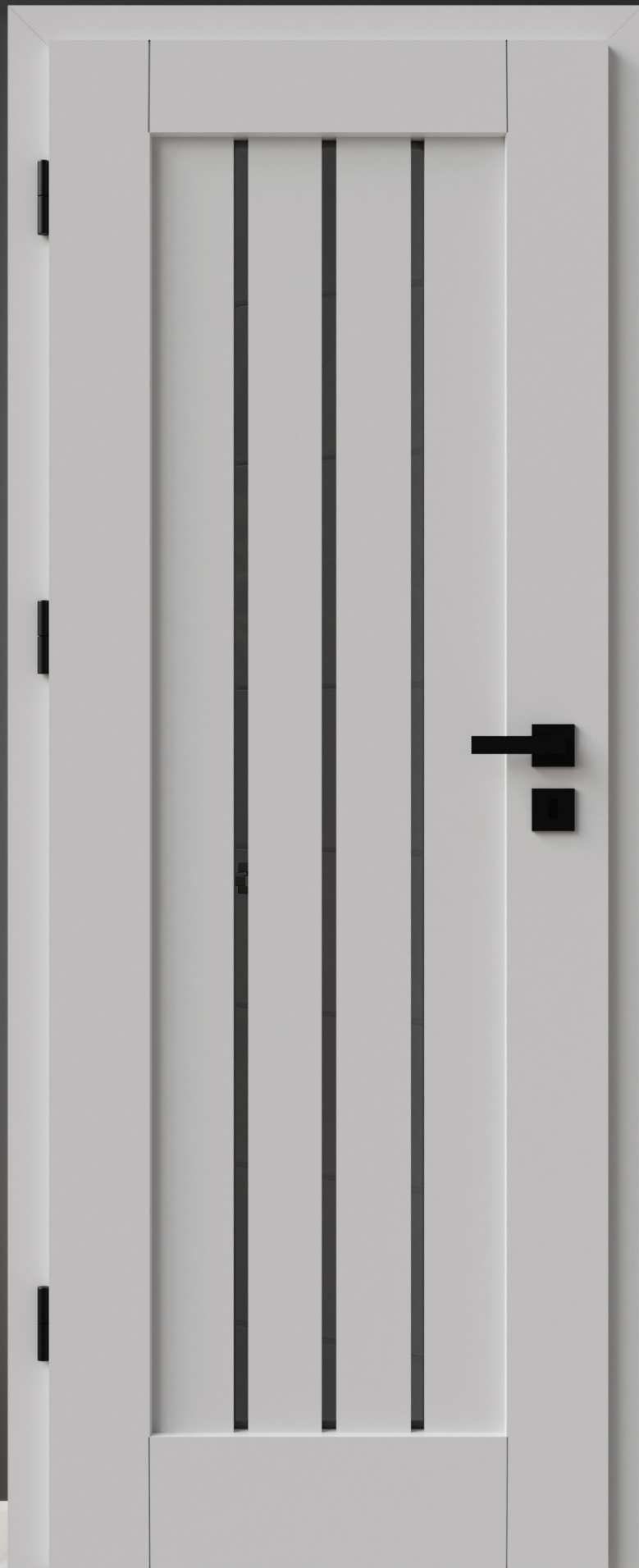

■ Modular doors

Modular doors construction	p. 3
Keri	p. 4-5
Arko	p. 6-7
Atos	p. 8-9
Erie	p. 10-11
Brytania	p. 12-13
Mira	p. 14-15
Ares	p. 16-17
Korfu	p. 18-19
Fresno	p. 20-21
Evia	p. 22-23
Alfa	p. 24-25
Tytan	p. 26-27
Toronto	p. 28-29
Retro	p. 30-31
Elegant	p. 32-33
Thor	p. 34-35
Margo	p. 36-37

■ Flush doors

Flush doors construction	str. 38
Lago	str. 39
Roco	str. 40
Doro	str. 41
Klaro	str. 42
Preston Plus	str. 43

■ Investment doors

Investment doors construction	p. 44
Uno	p. 45
Linus/Linos Alu	p. 46
Solid Pro/Solid Pro Alu	p. 47
Volume/Volume Alu	p. 48
Volume Set, Volume Alu Set	p. 49

■ Systems

Double-door	p. 50
On-wall system	p. 51
Hidden cassette system	p. 52
Design Line On-wall system	p. 53
Sara Pro secret system	p. 54

■ Frames

Flooring skirts	p. 55
Adjustable frame/tunnel 45°	p. 56
Adjustable frame/tunnel 90°	p. 57
Nonrebated frame	p. 58
Nonrebated frame 90°	p. 59
Soft edge fixed frame	p. 60
Overlay frame	p. 61

■ Information

Dimensions	p. 62
Colours	p. 63



CONSTRUCTION OF THE DOOR LEAF

MODULAR DOORS |

Rebated and nonrebated modular interior doors characterize by a stable and innovative construction made of solid MDF, as well as modern and interesting design. Each of the door leaf modules is wrapped with due care without any visible veneer joints. The elements are thoroughly connected to create a durable and sturdy door leaf structure. Carefully crafted modular doors are a new generation of doors that comprise of a robust structure and vast configuration possibilities. An extensive range of colors and wide selection of models allows to meet the most demanding design concepts.

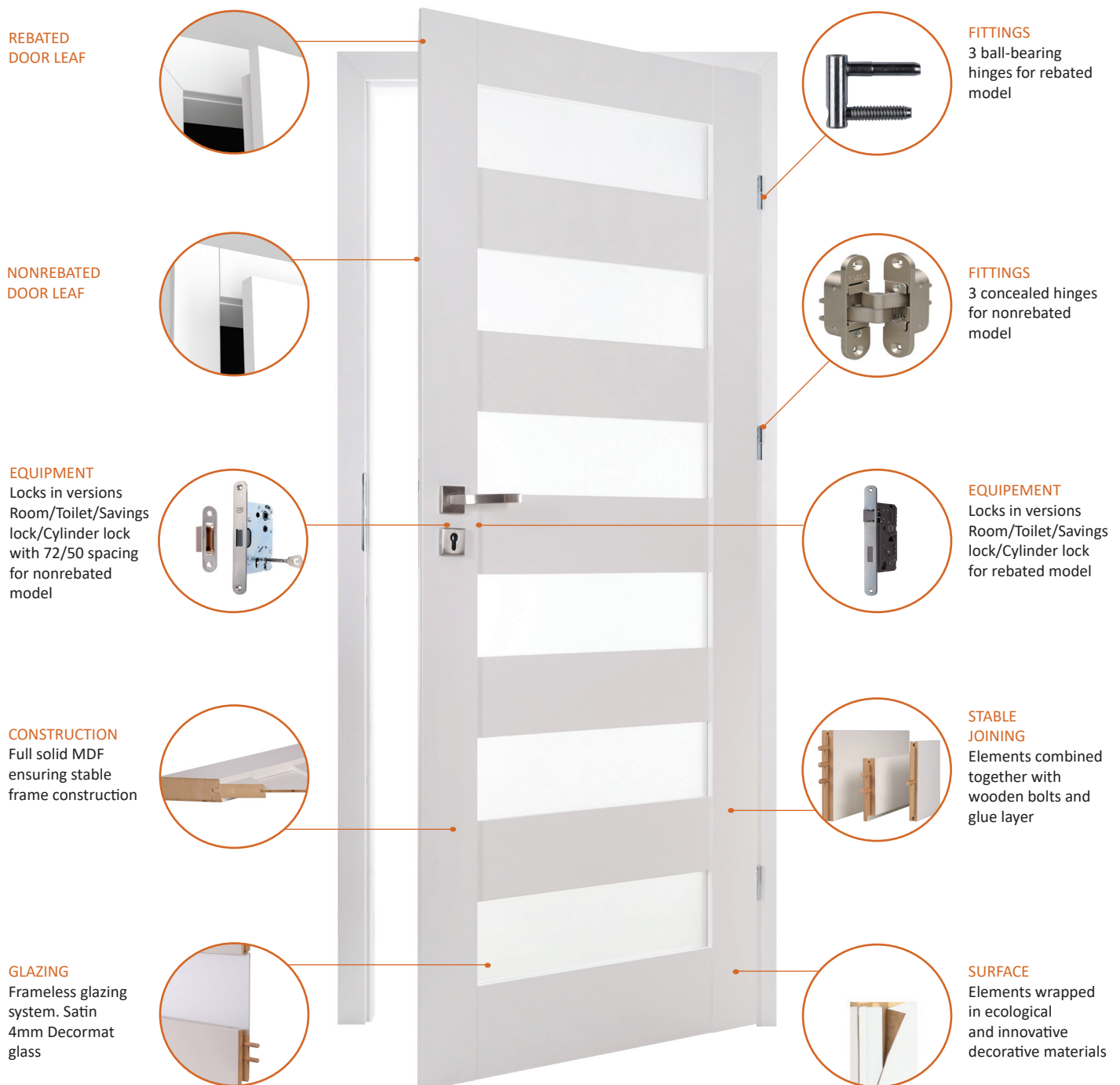



— Keri 1. Presented model in white CPL with black glass.

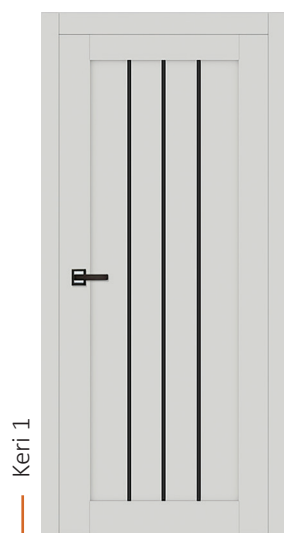

— Keri 1



— Keri 3



AVAILABLE DÉCORS



Laminat CPL

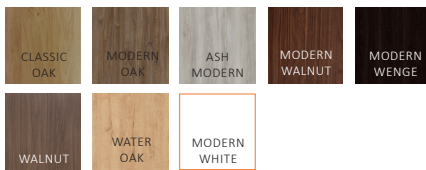

Ecoline

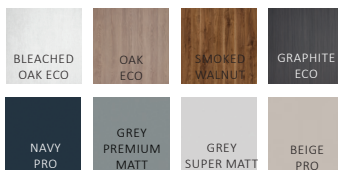

AVAILABLE MODELS

rebated



nonrebated



COMPLETE WITH

fixed frame

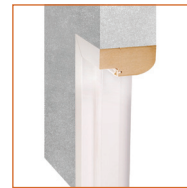

adjustable frame



overlay frame



AVAILABLE WIDTHS

- 60 cm/70cm/80 cm/90cm
- 100 cm - extra charge
- 40 cm- double-door system addition

CONSTRUCTION

- solid MDF stable frame construction
- 4mm DECORMAT satin glass

INCLUDED IN SET

- lock in versions Room/Toilet/Savings/Cylinder
- magnetic door lock in nonrebated model
- 3 ball-bearing hinges in rebated model
- 3 concealed hinges in nonrebated model

TECHNICAL DATA

- general information p. 3
- dimensions p. 62

EXTRA CHARGE OPTIONS

- nonrebated door
- sliding door system
- 100cm sized door
- ventilation undercut
- ventilation tubes
- black VSG safety glass

AVAILABLE SOLUTIONS

AVAILABLE SOLUTIONS	PAGE
- double-door system	50
- on-wall system	51
- hidden cassette system	52
- adjustable frame	56
- soft edge fixed frame	60
- nonrebated frame	58
- overlay frame	61



Arko 1 Presented model in siberian oak.



Arko 2



Arko 3



Arko 6



AVAILABLE DÉCORS

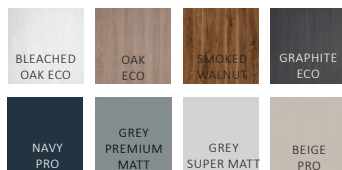
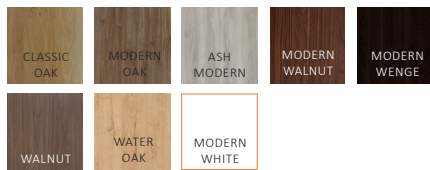
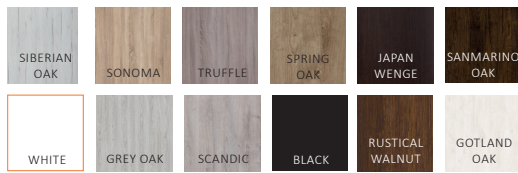

AVAILABLE MODELS

rebated



nonrebated



COMPLETE WITH

fixed frame

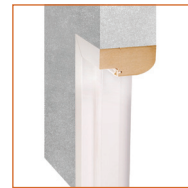

adjustable frame



overlay frame



AVAILABLE WIDTHS

- 60 cm/70cm/80 cm/90cm
- 100 cm - extra charge
- 40 cm- double-door system addition

CONSTRUCTION

- solid MDF stable frame construction
- 4mm DECORMAT satin glass

INCLUDED IN SET

- lock in versions Room/Toilet/Savings/Cylinder
- magnetic door lock in nonrebated model
- 3 ball-bearing hinges in rebated model
- 3 concealed hinges in nonrebated model

TECHNICAL DATA

- general information p. 3
- dimensions p. 62

EXTRA CHARGE OPTIONS

- nonrebated door
- sliding door system
- 100cm sized door
- ventilation undercut
- ventilation tubes
- black glass

AVAILABLE SOLUTIONS

AVAILABLE SOLUTIONS	PAGE
- double-door system	50
- on-wall system	51
- hidden cassette system	52
- adjustable frame	56
- soft edge fixed frame	60
- nonrebated frame	58
- overlay frame	61



Atos 1. Presented model in oak eco.



Atos 2



Atos 3



Atos 4



AVAILABLE DÉCORS

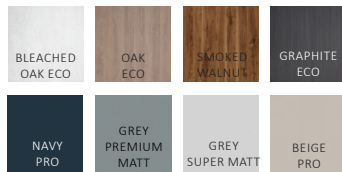

AVAILABLE MODELS

rebated



nonrebated



COMPLETE WITH

fixed frame

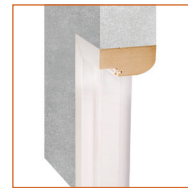

adjustable frame



overlay frame



AVAILABLE WIDTHS

- 60 cm/70cm/80 cm/90cm
- 100 cm - extra charge
- 40 cm - double-door system addition

CONSTRUCTION

- solid MDF stable frame construction
- 4mm DECORMAT satin glass

INCLUDED IN SET

- lock in versions Room/Toilet/Savings/Cylinder
- magnetic door lock in nonrebated model
- 3 ball-bearing hinges in rebated model
- 3 concealed hinges in nonrebated model

TECHNICAL DATA

- general information p. 3
- dimensions p. 62

EXTRA CHARGE OPTIONS

- nonrebated door
- sliding door system
- 100cm sized door
- ventilation undercut
- ventilation tubes

AVAILABLE SOLUTIONS

AVAILABLE SOLUTIONS	PAGE
- double-door system	50
- on-wall system	51
- hidden cassette system	52
- adjustable frame	56
- soft edge fixed frame	60
- nonrebated frame	58
- overlay frame	61



— Erie 1. Presented model in siberian oak.



— Erie 2



— Erie 3



— Erie 6



AVAILABLE DÉCORS

Top-Decor



Laminat CPL

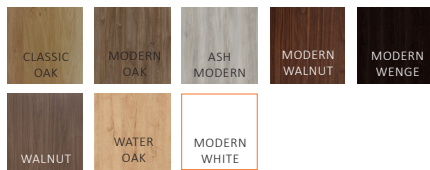

Ecoline

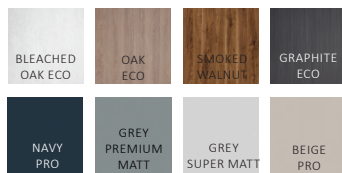

AVAILABLE MODELS

rebated



nonrebated



COMPLETE WITH

fixed frame

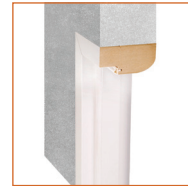

adjustable frame



overlay frame



AVAILABLE WIDTHS

- 60 cm/70cm/80 cm/90cm
- 100 cm - extra charge
- 40 cm- double-door system addition

CONSTRUCTION

- solid MDF stable frame construction
- 4mm DECORMAT satin glass

INCLUDED IN SET

- lock in versions Room/Toilet/Savings/Cylinder
- magnetic door lock in nonrebated model
- 3 ball-bearing hinges in rebated model
- 3 concealed hinges in nonrebated model

TECHNICAL DATA

- general information p. 3
- dimensions p. 62

EXTRA CHARGE OPTIONS

- nonrebated door
- sliding door system
- 100cm sized door
- ventilation undercut
- ventilation tubes

AVAILABLE SOLUTIONS

AVAILABLE SOLUTIONS	PAGE
- double-door system	50
- on-wall system	51
- hidden cassette system	52
- adjustable frame	56
- soft edge fixed frame	60
- nonrebated frame	58
- overlay frame	61



— Brytania 1. Presented model in classic oak.



— Brytania 2



— Brytania 3



— Brytania 5



AVAILABLE DÉCORS



AVAILABLE MODELS

rebated



nonrebated



COMPLETE WITH

fixed frame

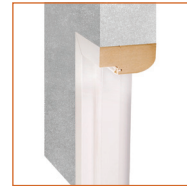

adjustable frame



overlay frame



AVAILABLE WIDTHS

- 60 cm/70cm/80 cm/90cm
- 100 cm - extra charge
- 40 cm - double-door system addition

CONSTRUCTION

- solid MDF stable frame construction
- 4mm DECORMAT satin glass

INCLUDED IN SET

- lock in versions Room/Toilet/Savings/Cylinder
- magnetic door lock in nonrebated model
- 3 ball-bearing hinges in rebated model
- 3 concealed hinges in nonrebated model

TECHNICAL DATA

- general information p. 3
- dimensions p. 62

EXTRA CHARGE OPTIONS

- nonrebated door
- sliding door system
- 100cm sized door
- ventilation undercut
- ventilation tubes

AVAILABLE SOLUTIONS

AVAILABLE SOLUTIONS	PAGE
- double-door system	50
- on-wall system	51
- hidden cassette system	52
- adjustable frame	56
- soft edge fixed frame	60
- nonrebated frame	58
- overlay frame	61



— Mira 1. Presented model in sanmarino walnut.



— Mira 2



— Mira 3



— Mira 8



AVAILABLE DÉCORS

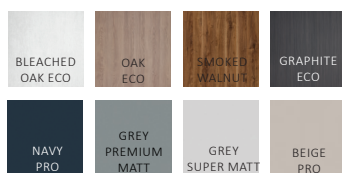
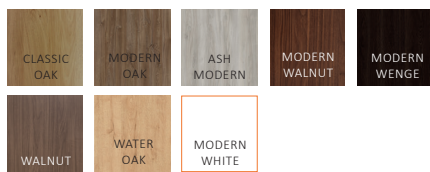
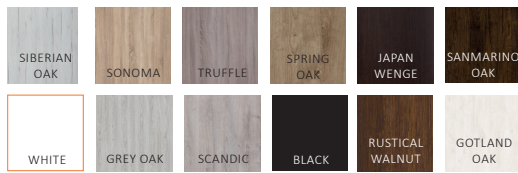

AVAILABLE MODELS

rebated



nonrebated



COMPLETE WITH

fixed frame

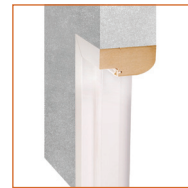

adjustable frame



overlay frame



AVAILABLE WIDTHS

- 60 cm/70cm/80 cm/90cm
- 100 cm - extra charge
- 40 cm - double-door system addition

CONSTRUCTION

- solid MDF stable frame construction
- 4mm DECORMAT satin glass

INCLUDED IN SET

- lock in versions Room/Toilet/Savings/Cylinder
- magnetic door lock in nonrebated model
- 3 ball-bearing hinges in rebated model
- 3 concealed hinges in nonrebated model

TECHNICAL DATA

- general information p. 3
- dimensions p. 62

EXTRA CHARGE OPTIONS

- nonrebated door
- sliding door system
- 100cm sized door
- ventilation undercut
- ventilation tubes
- black glass

AVAILABLE SOLUTIONS

AVAILABLE SOLUTIONS	PAGE
- double-door system	50
- on-wall system	51
- hidden cassette system	52
- adjustable frame	56
- soft edge fixed frame	60
- nonrebated frame	58
- overlay frame	61



— Ares 1. Presented model in siberian oak.



— Ares 2



— Ares 3



— Ares 5



AVAILABLE DÉCORS

Top-Decor

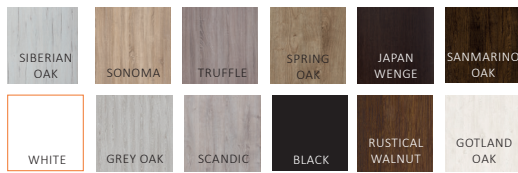

Laminat CPL

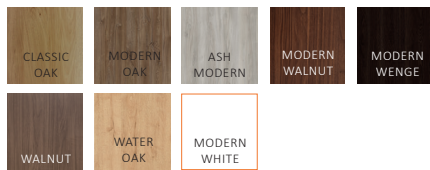

Ecoline

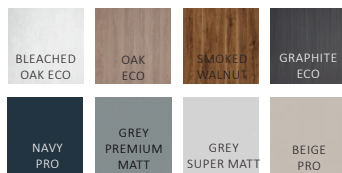

AVAILABLE MODELS

rebated



nonrebated



COMPLETE WITH

fixed frame

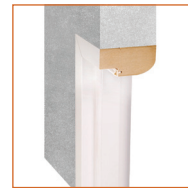

adjustable frame



overlay frame



AVAILABLE WIDTHS

- 60 cm/70cm/80 cm/90cm
- 100 cm - extra charge
- 40 cm - double-door system addition

CONSTRUCTION

- solid MDF stable frame construction
- 4mm DECORMAT satin glass

INCLUDED IN SET

- lock in versions Room/Toilet/Savings/Cylinder
- magnetic door lock in nonrebated model
- 3 ball-bearing hinges in rebated model
- 3 concealed hinges in nonrebated model

TECHNICAL DATA

- general information p. 3
- dimensions p. 62

EXTRA CHARGE OPTIONS

- nonrebated door
- sliding door system
- 100cm sized door
- ventilation undercut
- ventilation tubes

AVAILABLE SOLUTIONS

AVAILABLE SOLUTIONS	PAGE
- double-door system	50
- on-wall system	51
- hidden cassette system	52
- adjustable frame	56
- soft edge fixed frame	60
- nonrebated frame	58
- overlay frame	61



— Korfu 1. Presented model in smoked walnut.



— Korfu 2



— Korfu 3



— Korfu 8



AVAILABLE DÉCORS

Top-Decor



Laminat CPL

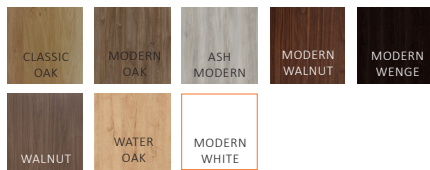

Ecoline

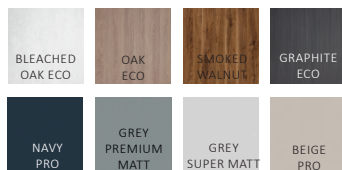

AVAILABLE MODELS

rebated



nonrebated



COMPLETE WITH

fixed frame

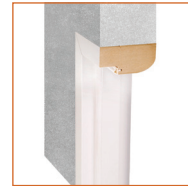

adjustable frame



overlay frame



AVAILABLE WIDTHS

- 60 cm/70cm/80 cm/90cm
- 100 cm - extra charge
- 40 cm - double-door system addition

CONSTRUCTION

- solid MDF stable frame construction
- 4mm DECORMAT satin glass

INCLUDED IN SET

- lock in versions Room/Toilet/Savings/Cylinder
- magnetic door lock in nonrebated model
- 3 ball-bearing hinges in rebated model
- 3 concealed hinges in nonrebated model

TECHNICAL DATA

- general information p. 3
- dimensions p. 62

EXTRA CHARGE OPTIONS

- nonrebated door
- sliding door system
- 100cm sized door
- ventilation undercut
- ventilation tubes

AVAILABLE SOLUTIONS

AVAILABLE SOLUTIONS	PAGE
- double-door system	50
- on-wall system	51
- hidden cassette system	52
- adjustable frame	56
- soft edge fixed frame	60
- nonrebated frame	58
- overlay frame	61



Fresno 1. Presented model in bleached oak eco.



Fresno 2



Fresno 3



Fresno 6



AVAILABLE DÉCORS

Top-Decor

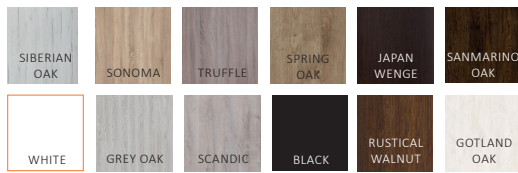

Laminat CPL

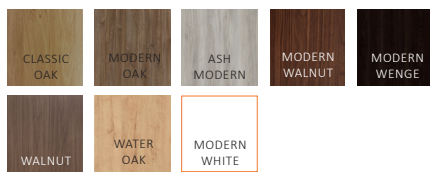

Ecoline

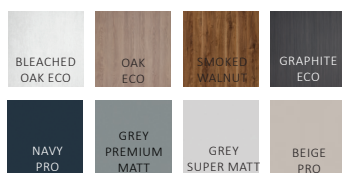

AVAILABLE MODELS

rebated



nonrebated



COMPLETE WITH

fixed frame

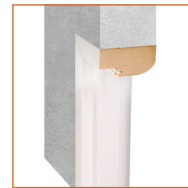

adjustable frame



overlay frame



AVAILABLE WIDTHS

- 60 cm/70cm/80 cm/90cm
- 100 cm - extra charge
- 40 cm - double-door system addition

CONSTRUCTION

- solid MDF stable frame construction
- 4mm DECORMAT satin glass

INCLUDED IN SET

- lock in versions Room/Toilet/Savings/Cylinder
- magnetic door lock in nonrebated model
- 3 ball-bearing hinges in rebated model
- 3 concealed hinges in nonrebated model

TECHNICAL DATA

- general information p. 3
- dimensions p. 62

EXTRA CHARGE OPTIONS

- nonrebated door
- sliding door system
- 100cm sized door
- ventilation undercut
- ventilation tubes

AVAILABLE SOLUTIONS

AVAILABLE SOLUTIONS	PAGE
- double-door system	50
- on-wall system	51
- hidden cassette system	52
- adjustable frame	56
- soft edge fixed frame	60
- nonrebated frame	58
- overlay frame	61



— Evia 1. Presented model in spring oak.



— Evia 2



— Evia 3



— Evia 5



AVAILABLE DÉCORS

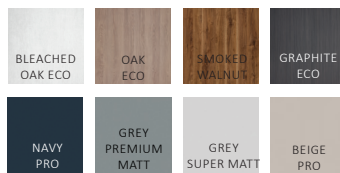
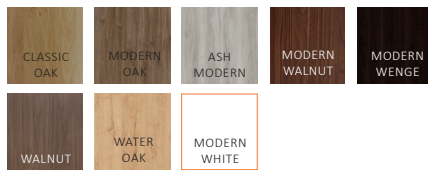

AVAILABLE MODELS

rebated



nonrebated



COMPLETE WITH

fixed frame

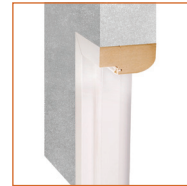

adjustable frame



overlay frame



AVAILABLE WIDTHS

- 60 cm/70cm/80 cm/90cm
- 100 cm - extra charge
- 40 cm - double-door system addition

CONSTRUCTION

- solid MDF stable frame construction
- 4mm DECORMAT satin glass

INCLUDED IN SET

- lock in versions Room/Toilet/Savings/Cylinder
- magnetic door lock in nonrebated model
- 3 ball-bearing hinges in rebated model
- 3 concealed hinges in nonrebated model

TECHNICAL DATA

- general information p. 3
- dimensions p. 62

EXTRA CHARGE OPTIONS

- nonrebated door
- sliding door system
- 100cm sized door
- ventilation undercut
- ventilation tubes

AVAILABLE SOLUTIONS

AVAILABLE SOLUTIONS	PAGE
- double-door system	50
- on-wall system	51
- hidden cassette system	52
- adjustable frame	56
- soft edge fixed frame	60
- nonrebated frame	58
- overlay frame	61



— Alfa 1. Presented model in sonoma.



— Alfa 2



— Alfa 3



— Alfa 9



AVAILABLE DÉCORS

Top-Decor

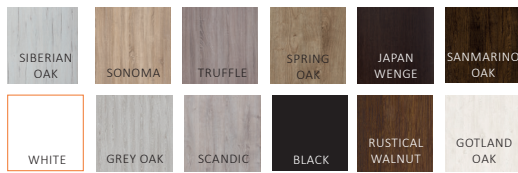

Laminat CPL

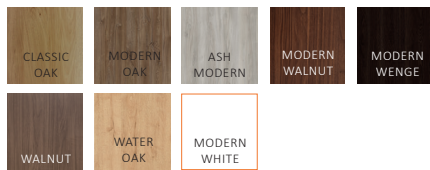

Ecoline

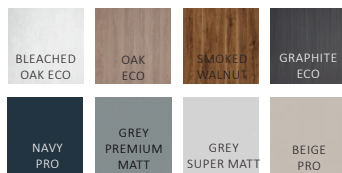

AVAILABLE MODELS

rebated



nonrebated



COMPLETE WITH

fixed frame

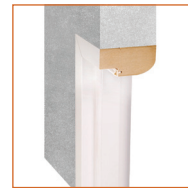

adjustable frame



overlay frame



AVAILABLE WIDTHS

- 60 cm/70cm/80 cm/90cm
- 100 cm - extra charge
- 40 cm - double-door system addition

CONSTRUCTION

- solid MDF stable frame construction
- 4mm DECORMAT satin glass

INCLUDED IN SET

- lock in versions Room/Toilet/Savings/Cylinder
- magnetic door lock in nonrebated model
- 3 ball-bearing hinges in rebated model
- 3 concealed hinges in nonrebated model

TECHNICAL DATA

- general information p. 3
- dimensions p. 62

EXTRA CHARGE OPTIONS

- nonrebated door
- sliding door system
- 100cm sized door
- ventilation undercut
- ventilation tubes

AVAILABLE SOLUTIONS

AVAILABLE SOLUTIONS	PAGE
- double-door system	50
- on-wall system	51
- hidden cassette system	52
- adjustable frame	56
- soft edge fixed frame	60
- nonrebated frame	58
- overlay frame	61



Tytan 1. Presented model in modern oak.



Tytan 2



Tytan 3



Tytan 5



AVAILABLE DÉCORS

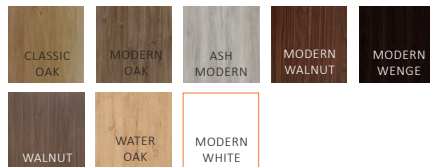

AVAILABLE MODELS

rebated



nonrebated



COMPLETE WITH

fixed frame

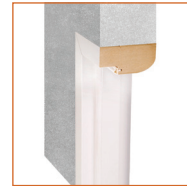

adjustable frame



overlay frame



AVAILABLE WIDTHS

- 60 cm/70cm/80 cm/90cm
- 100 cm - extra charge
- 40 cm - double-door system addition

CONSTRUCTION

- solid MDF stable frame construction
- 4mm DECORMAT satin glass

INCLUDED IN SET

- lock in versions Room/Toilet/Savings/Cylinder
- magnetic door lock in nonrebated model
- 3 ball-bearing hinges in rebated model
- 3 concealed hinges in nonrebated model

TECHNICAL DATA

- general information p. 3
- dimensions p. 62

EXTRA CHARGE OPTIONS

- nonrebated door
- sliding door system
- 100cm sized door
- ventilation undercut
- ventilation tubes

AVAILABLE SOLUTIONS

AVAILABLE SOLUTIONS	PAGE
- double-door system	50
- on-wall system	51
- hidden cassette system	52
- adjustable frame	56
- soft edge fixed frame	60
- nonrebated frame	58
- overlay frame	61



Toronto 1. Presented model in sanmarino walnut.



Toronto 2



Toronto 3



Toronto 6



AVAILABLE DÉCORS

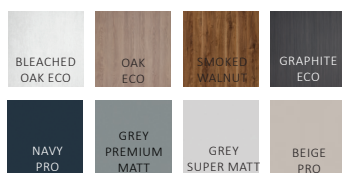
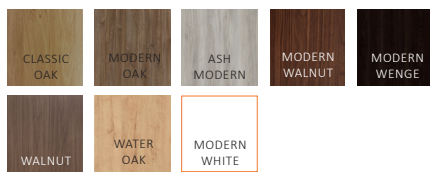
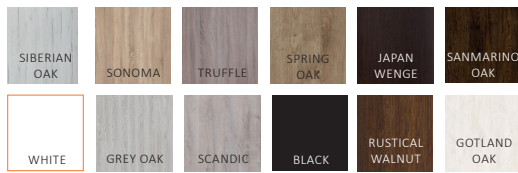

AVAILABLE MODELS

rebated



nonrebated



COMPLETE WITH

fixed frame

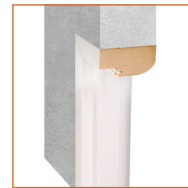

adjustable frame



overlay frame



AVAILABLE WIDTHS

- 60 cm/70cm/80 cm/90cm
- 100 cm - extra charge
- 40 cm - double-door system addition

CONSTRUCTION

- solid MDF stable frame construction
- 4mm DECORMAT satin glass

INCLUDED IN SET

- lock in versions Room/Toilet/Savings/Cylinder
- magnetic door lock in nonrebated model
- 3 ball-bearing hinges in rebated model
- 3 concealed hinges in nonrebated model

TECHNICAL DATA

- general information p. 3
- dimensions p. 62

EXTRA CHARGE OPTIONS

- nonrebated door
- sliding door system
- 100cm sized door
- ventilation undercut
- ventilation tubes

AVAILABLE SOLUTIONS

AVAILABLE SOLUTIONS	PAGE
- double-door system	50
- on-wall system	51
- hidden cassette system	52
- adjustable frame	56
- soft edge fixed frame	60
- nonrebated frame	58
- overlay frame	61

Retro 1. Presented model in sanmarino walnut.



Retro 2



AVAILABLE DÉCORS

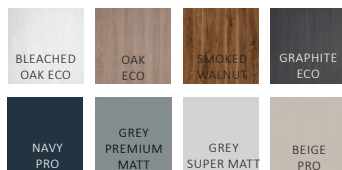
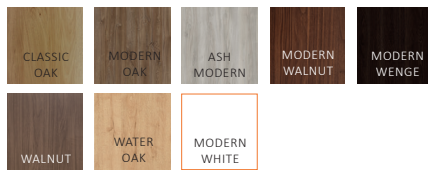
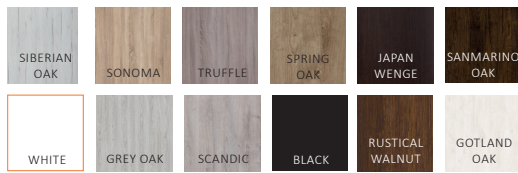

AVAILABLE MODELS

rebated



nonrebated



COMPLETE WITH

fixed frame

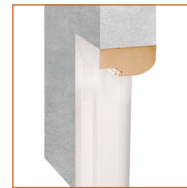

adjustable frame



overlay frame



AVAILABLE WIDTHS

- 60 cm/70cm/80 cm/90cm
- 100 cm - extra charge
- 40 cm - double-door system addition

CONSTRUCTION

- solid MDF stable frame construction
- 4mm DECORMAT satin glass

INCLUDED IN SET

- lock in versions Room/Toilet/Savings/Cylinder
- magnetic door lock in nonrebated model
- 3 ball-bearing hinges in rebated model
- 3 concealed hinges in nonrebated model

TECHNICAL DATA

- general information p. 3
- dimensions p. 62

EXTRA CHARGE OPTIONS

- nonrebated door
- sliding door system
- 100cm sized door
- ventilation undercut
- ventilation tubes

AVAILABLE SOLUTIONS

AVAILABLE SOLUTIONS	PAGE
- double-door system	50
- on-wall system	51
- hidden cassette system	52
- adjustable frame	56
- soft edge fixed frame	60
- nonrebated frame	58
- overlay frame	61



Elegant 1. Presented model in modern oak.



Elegant 2



Elegant 3



AVAILABLE DÉCORS

Laminat CPL

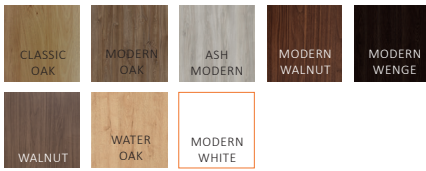

Ecoline

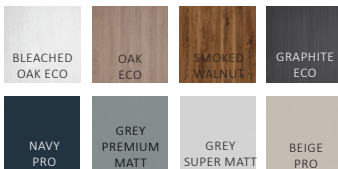

AVAILABLE MODELS

rebated



nonrebated



COMPLETE WITH

fixed frame

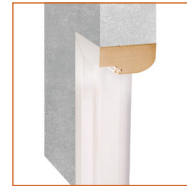

adjustable frame



overlay frame



AVAILABLE WIDTHS

- 60 cm/70cm/80 cm/90cm
- 100 cm - extra charge
- 40 cm - double-door system addition

CONSTRUCTION

- solid MDF stable frame construction
- 4mm DECORMAT satin glass

INCLUDE IN SET

- lock in versions Room/Toilet/Savings/Cylinder
- magnetic door lock in nonrebated model
- 3 ball-bearing hinges in rebated model
- 3 concealed hinges in nonrebated model

TECHNICAL DATA

- general information p. 3
- dimensions p. 62

EXTRA CHARGE OPTIONS

- nonrebated door
- sliding door system
- 100cm sized door
- ventilation undercut
- ventilation tubes

AVAILABLE SOLUTIONS

AVAILABLE SOLUTIONS	PAGE
- double-door system	50
- on-wall system	51
- hidden cassette system	52
- adjustable frame	56
- soft edge fixed frame	60
- nonrebated frame	58
- overlay frame	61



— Thor 1. Presented model in ash modern.



— Thor 2



— Thor 3



AVAILABLE DÉCORS

Laminat CPL

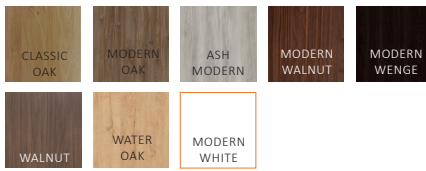

Ecoline

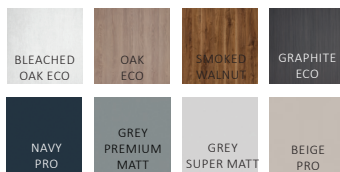

AVAILABLE MODELS

rebated



nonrebated



COMPLETE WITH

fixed frame

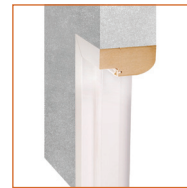

adjustable frame



overlay frame



AVAILABLE WIDTHS

- 60 cm/70cm/80 cm/90cm
- 100 cm - extra charge
- 40 cm - double-door system addition

CONSTRUCTION

- solid MDF stable frame construction
- 4mm DECORMAT satin glass

INCLUDE IN SET

- lock in versions Room/Toilet/Savings/Cylinder
- magnetic door lock in nonrebated model
- 3 ball-bearing hinges in rebated model
- 3 concealed hinges in nonrebated model

TECHNICAL DATA

- general information p. 3
- dimensions p. 62

EXTRA CHARGE OPTIONS

- nonrebated door
- sliding door system
- 100cm sized door
- ventilation undercut
- ventilation tubes

AVAILABLE SOLUTIONS

AVAILABLE SOLUTIONS	PAGE
- double-door system	50
- on-wall system	51
- hidden cassette system	52
- adjustable frame	56
- soft edge fixed frame	60
- nonrebated frame	58
- overlay frame	61



— Margo 1. Presented model in spring oak.



— Margo 2



AVAILABLE DÉCORS

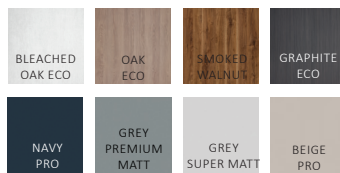
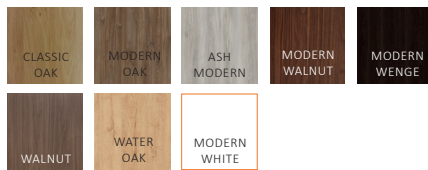

AVAILABLE MODELS

rebated



nonrebated



COMPLETE WITH

fixed frame

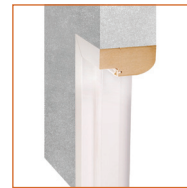

adjustable frame



overlay frame



AVAILABLE WIDTHS

- 60 cm/70cm/80 cm/90cm
- 100 cm - extra charge
- 40 cm - double-door system addition

CONSTRUCTION

- solid MDF stable frame construction
- 4mm DECORMAT satin glass

INCLUDE IN SET

- lock in versions Room/Toilet/Savings/Cylinder
- magnetic door lock in nonrebated model
- 3 ball-bearing hinges in rebated model
- 3 concealed hinges in nonrebated model

TECHNICAL DATA

- general information p. 3
- dimensions p. 62

EXTRA CHARGE OPTIONS

- nonrebated door
- sliding door system
- 100cm sized door
- ventilation undercut
- ventilation tubes
- black glass

AVAILABLE SOLUTIONS

AVAILABLE SOLUTIONS	PAGE
- double-door system	50
- on-wall system	51
- hidden cassette system	52
- adjustable frame	56
- soft edge fixed frame	60
- nonrebated frame	58
- overlay frame	61

CONSTRUCTION OF THE DOOR LEAF

FLUSH DOORS |

Classic collection line of doors characterize by an elegant and clean look.

An extensive range of configuration options as well as excellent workmanship will satisfy even the most demanding customer.

A frame glazing system and stabilizing "honeycomb" paper core are used throughout this collection line.

REBATED DOOR LEAF



EQUIPMENT
Locks in versions Room/Toilet/Savings lock/Cylinder lock with 72/50 spacing for rebated model



GLAZING
4mm Decormat satin glass finished with surrounding frame



FITTINGS
3 ball-bearing hinges for rebated model



CONSTRUCTION
MDF frame covered with 2 HDF boards wrapped in decorative materials, honeycomb filling



SURFACE
Elements wrapped in ecological and innovative decorative materials





AVAILABLE DÉCORS



AVAILABLE MODELS

rebated

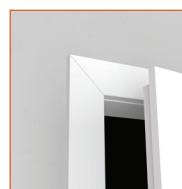

AVAILABLE WIDTHS

- 60 cm/70cm/80 cm/90cm
- 100 cm - extra charge

AVAILABLE SOLUTIONS

PAGE

- double-door system	50
- on-wall system	51
- hidden cassette system	52
- adjustable frame	56
- soft edge fixed frame	60
- overlay frame	61

INCLUDED IN SET

- lock in versions Room/Toilet/Savings/Cylinder
- 3 ball-bearing hinges in rebated model

EXTRA CHARGE OPTIONS

- sliding door system
- 100cm sized door
- ventilation grill
- ventilation tubes

TECHNICAL DATA

- general information p. 38
- dimensions p. 62

CONSTRUCTION

- MDF frame covered with 2 HDF boards wrapped in decorative materials
- 4mm DECORMAT satin glass



AVAILABLE DÉCORS

Top-Decor 



AVAILABLE MODELS

rebated

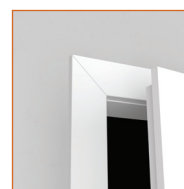

AVAILABLE WIDTHS

- 60 cm/70cm/80 cm/90cm
- 100 cm - extra charge

AVAILABLE SOLUTIONS	PAGE
- double-door system	50
- on-wall system	51
- hidden cassette system	52
- adjustable frame	56
- soft edge fixed frame	60
- overlay frame	61

INCLUDED IN SET

- lock in versions Room/Toilet/Savings/Cylinder
- 3 ball-bearing hinges in rebated model

TECHNICAL DATA

- general information p. 38
- dimensions p. 62

EXTRA CHARGE OPTIONS

- sliding door system
- 100cm sized door
- ventilation grill
- ventilation tubes

CONSTRUCTION

- MDF frame covered with 2 HDF boards wrapped in decorative materials
- 4mm DECORMAT satin glass





AVAILABLE DÉCORS



AVAILABLE MODELS

rebated



AVAILABLE WIDTHS

- 60 cm/70cm/80 cm/90cm
- 100 cm - extra charge

AVAILABLE SOLUTIONS

PAGE

- double-door system	50
- on-wall system	51
- hidden cassette system	52
- adjustable frame	56
- soft edge fixed frame	60
- overlay frame	61

INCLUDED IN SET

- lock in versions Room/Toilet/Savings/Cylinder
- 3 ball-bearing hinges in rebated model

EXTRA CHARGE OPTIONS

- sliding door system
- 100cm sized door
- ventilation grill
- ventilation tube

TECHNICAL DATA

- general information p. 38
- dimensions p. 62

CONSTRUCTION

- MDF frame covered with 2 HDF boards wrapped in decorative materials
- 4mm DECORMAT satin glass



AVAILABLE DÉCORS

Top-Decor



AVAILABLE MODELS

rebated

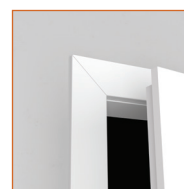

AVAILABLE WIDTHS

- 60 cm/70cm/80 cm/90cm

- 100 cm - extra charge

AVAILABLE SOLUTIONS

PAGE

- double-door system	50
- on-wall system	51
- hidden cassette system	52
- adjustable frame	56
- soft edge fixed frame	60
- overlay frame	61

INCLUDED IN SET

- lock in versions Room/Toilet/Savings/Cylinder
- 3 ball-bearing hinges in rebated model

EXTRA CHARGE OPTIONS

- sliding door system
- 100cm sized door
- ventilation grill
- ventilation tubes

TECHNICAL DATA

- general information p. 38
- dimensions p. 62

CONSTRUCTION

- MDF frame covered with 2 HDF boards wrapped in decorative materials
- 4mm DECORMAT satin glass





AVAILABLE DÉCORS

Top-Decor



AVAILABLE MODELS

rebated

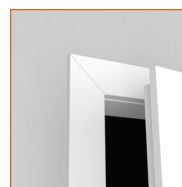

AVAILABLE WIDTHS

- 60 cm/70cm/80 cm/90cm
- 100 cm - extra charge

AVAILABLE SOLUTIONS

PAGE

- double-door system	50
- on-wall system	51
- hidden cassette system	52
- adjustable frame	56
- soft edge fixed frame	60
- overlay frame	61

INCLUDED IN SET

- lock in versions Room/Toilet/Savings/Cylinder
- 3 ball-bearing hinges in rebated model

EXTRA CHARGE OPTIONS

- sliding door system
- 100cm sized door
- ventilation grill
- ventilation tubes

TECHNICAL DATA

- general information p. 38
- dimensions p. 62

CONSTRUCTION

- MDF frame covered with 2 HDF boards wrapped in decorative materials
- 4mm DECORMAT satin glass

CONSTRUCTION OF THE DOOR LEAF

INVESTMENT DOOR |

Investment door collection is dedicated for residential and public utility construction as an interior entrance doors.

In this section you can find both budget, strengthened, acoustic and anti-theft doors along with full sets containing frames, threshold and see-through viewfinder.

REBATED
DOOR LEAF



EQUIPMENT
Locks in versions
Room/Toilet/Savings
lock/Cylinder lock
with 72/50 spacing
for rebated model



CONSTRUCTION
MDF frame covered
with 2 HDF boards
wrapped in
decorative materials
„CHIPBOARD” filling
for model „Solid”



FITTINGS
ball-bearing hinges

CONSTRUCTION
MDF frame covered
with 2 HDF boards
wrapped in
decorative materials,
honeycomb filling for
model „UNO”

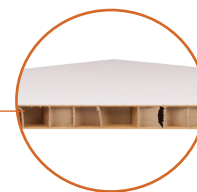

CONSTRUCTION
Double MDF frame
and pine with 2 HDF
boards wrapped in
decorative materials,
„HOMALIGHT” filling
for model „Volume”



SURFACE
Elements wrapped
in ecological and
innovative decorative
materials





AVAILABLE DÉCORS

Top-Decor



Laminat CPL

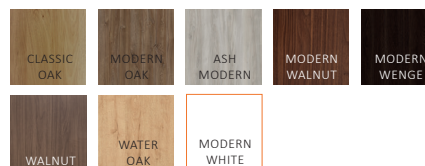

Uno

AVAILABLE MODELS

rebated

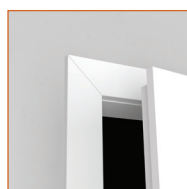

nonrebated



AVAILABLE WIDTHS

- 60 cm/70cm/80 cm/90cm

- 100 cm - extra charge

AVAILABLE SOLUTIONS

PAGE

- double-door system	50
- on-wall system	51
- hidden cassette system	52
- adjustable frame	56
- fixed frame	60
- overlay frame	61

INCLUDED IN SET

- lock in versions Room/Toilet/Savings/Cylinder
- 3 ball-bearing hinges in rebated model

EXTRA CHARGE OPTIONS

- sliding door system
- 100cm sized door
- ventilation grill
- ventilation tubes
- nonrebated door
- ventilation undercut

TEHCHNICAL DATA

- general information p. 3
- dimensions p. 62



AVAILABLE DÉCORS

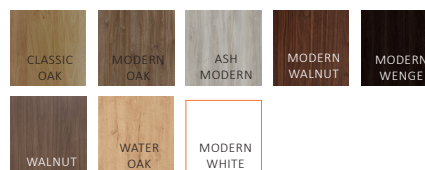

INCLUDED IN SET

- lock in versions Room/Toilet/Savings/Cylinder
- 3 ball-bearing hinges in rebated model

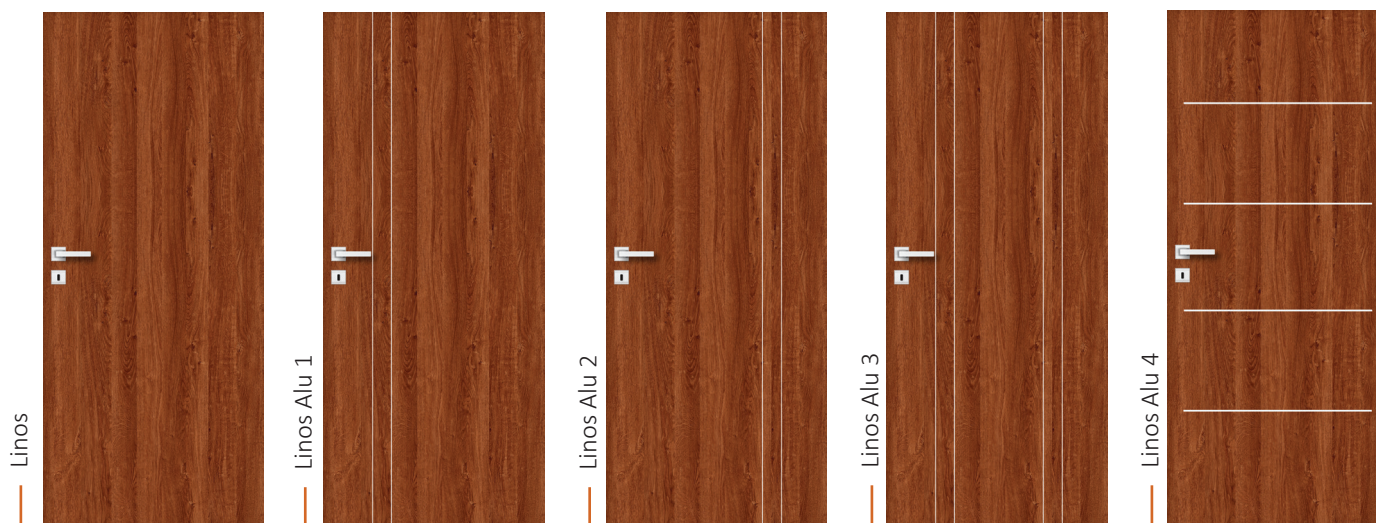

AVAILABLE WIDTHS

- 60 cm/70cm/80 cm/90cm
- 100 cm - extra charge

AVAILABLE SOLUTIONS

AVAILABLE SOLUTIONS	PAGE
- adjustable frame	56
- fixed frame	60
- overlay frame	61

EXTRA CHARGE OPTIONS

- self closing system
- 100cm sized door
- ventilation undercut
- ventilation tubes
- porthole
- kick plates

CONSTRUCTION

- MDF frame covered with 2 HDF boards
- HOMALIGHT filling





AVAILABLE DÉCORS

Top-Decor



Laminat CPL

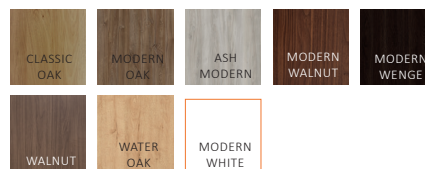

Solid Pro



Solid Pro Alu 1



Solid Pro Alu 2



Solid Pro Alu 3



Solid Pro Alu 4



AVAILABLE WIDTHS

- 80 cm/90cm

AVAILABLE SOLUTIONS

- adjustable enhanced frame
- wooden fixed frame

PAGE

- 56
- 60

INCLUDED IN SET

- insertion 3 bolted lock + upper lock
- 3 ball-bearing hinges in rebated model

EXTRA CHARGE OPTIONS

- self closing system
- stainless steel threshold
- kick plates

CONSTRUCTION

- pine frame covered with 2 HDF boards
- chipboard filling
- square-edge technology



AVAILABLE DÉCORS

Top-Dekor

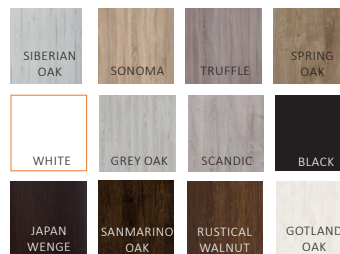

Laminat CPL

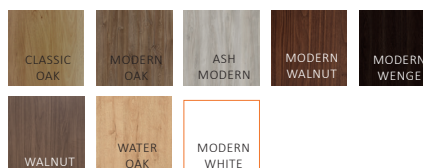

Volume



Volume Alu 1



Volume Alu 2



Volume Alu 3



Volume Alu 4



AVAILABLE SOLUTIONS

- adjustable enhanced frame
- wooden fixed frame

PAGE

- 56
- 60

EXTRA CHARGE OPTIONS

- self closing system
- stainless steel threshold
- kick plates

INCLUDED IN SET

- insertion 3 bolted lock + upper lock
- 3 ball-bearing hinges
- anti-pry bolts
- seal installed in door

CONSTRUCTION

- pine frame covered with 2 HDF boards
- HOMALIFIGHT filling

AVAILABLE WIDTHS

- 80 cm/90cm





AVAILABLE DÉCORS

Top-Decor

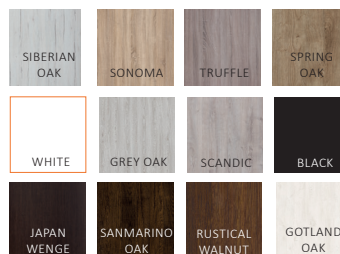

Laminat CPL

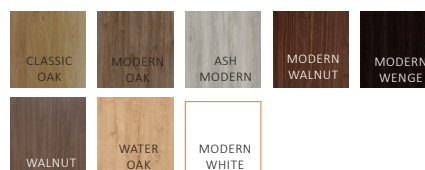

Volume Set



Volume Set Alu 1



Volume Set Alu 2



Volume Set Alu 3



Volume Set Alu 4



INCLUDED IN SET

- insertion 3 bolted lock + upper lock
- 3 ball-bearing hinges
- anti-pry bolts
- seal installed in door
- see-through viewfinder (self assembly kit)
- door handle with upper rosette "MATI"
- stainless steel threshold
- wooden fixed frame

EXTRA CHARGE OPTIONS

- self closing system
- kick plates

CONSTRUCTION

- pine frame covered with 2 HDF boards
- HOMALIFIGHT filling

AVAILABLE WIDTHS

- 80 cm/90cm



On double doors system any door model except Linos, Solid and Volume can be used. It is possible to make combination with doors dimensions 60-90 chosen freely. The active door leaf opens and closes by standard while passive door has a recess cut for a latch and fixed astragal.

After drilling in the head casing and floor there is possibility to anchor the latches.

Price for the double door system contains the price of each door from the set, astragal will be charged separately.

Double door system frame price is 30% higher.

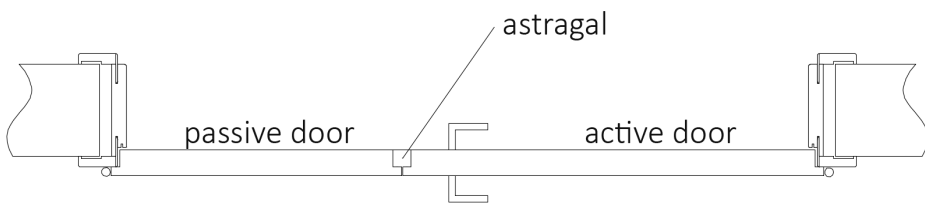

DOUBLE-DOOR
PASSIVE LEFT, ACTIVE RIGHT

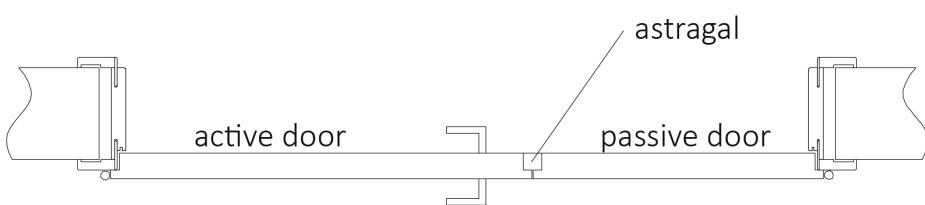

DOUBLE-DOOR
PASSIVE RIGHT, ACTIVE LEFT





INCLUDED IN SET

- aluminium rail rollers and installation kit
- distancing bar
- masking shield in colour matched to the door
- buffer bar in colour matched to the door (Not available in the double-door system)

DESIGNATION

With the on-wall sliding system a nonrebated sliding door is used with following sizes:

- singular system: „60“, „70“, „80“, „90“,
 - double-door system „2x60“, „2x70“, „2x80“, „2x90“.
- In this version all the catalogue's models are available except models: Linos, Solid, Volume.
In case modular door usage there is no possibility of making ventilation undercut.

EXTRA CHARGE OPTIONS

steel oval, round silver or golden handles 2 pieces

hook lock with set of oval or round handles
in versions Room/Toilet in golden or chrome

symmetric-system that allows to slide doors on both directions at the same time

retarder

Double system

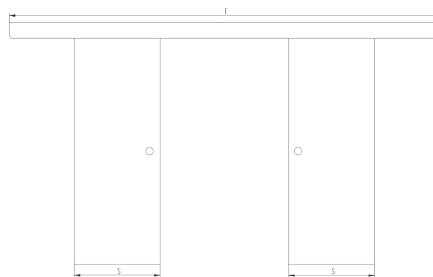

Singular right

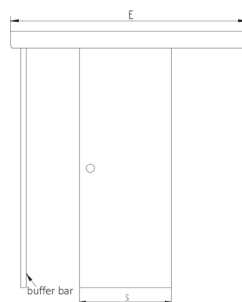

Singular left

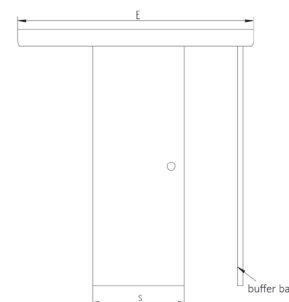

Singular door system				
	60	70	80	90
S	644	744	844	944
E	1682	1682	1982	1982

Double-door system				
	2x60	2x70	2x80	2x90
S	2x644	2x744	2x844	2x944
E	3332	3332	3996	3996

Dimensions (width)- singular door system

Dimensions (width)- double-door system

	60	70	80	90
S	644	744	844	944
A	602	702	802	902
B	646	746	846	946
C	680	780	880	980
D	744	844	944	1044

	2x60	2x70	2x80	2x90
S	2x644	2x744	2x844	2x944
A	1250	1450	1650	1850
B	1243	1443	1643	1843
C	1294	1494	1694	1894
D	1392	1592	1792	1992

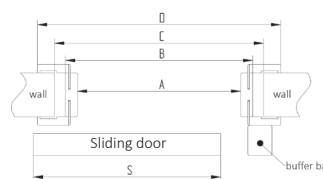

On-wall sliding masked system

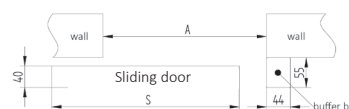

On-wall sliding system without mask

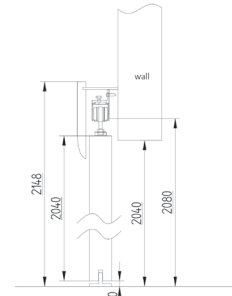
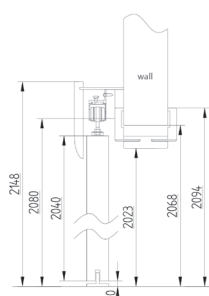

Hidden cassette system

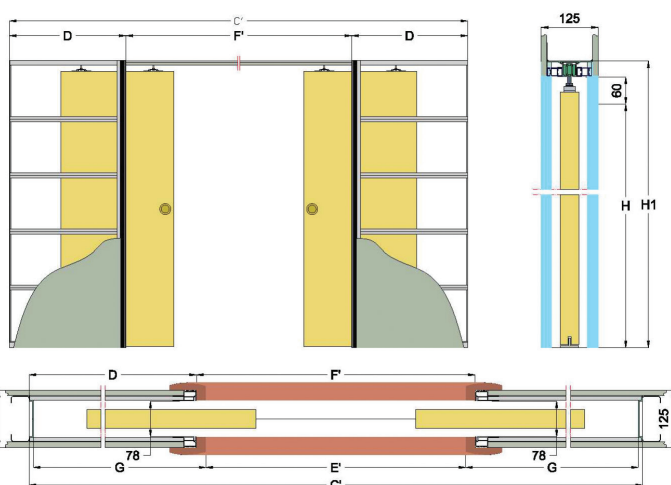
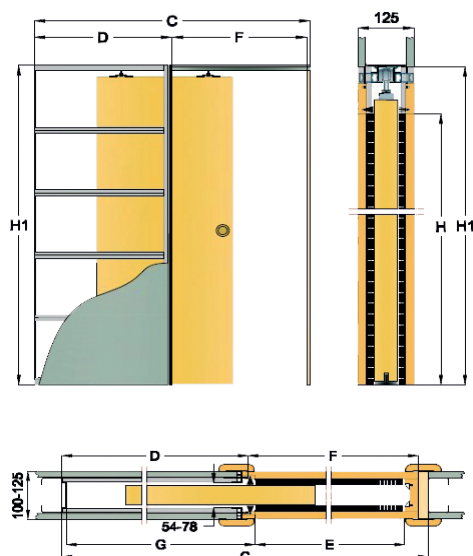

DESIGNATION

For hidden cassette system a nonrebated door is used with following dimensions:

- singular system: „60“, „70“, „80“, „90“
- double-door system „2x60“, „2x70“, „2x80“, „2x90“

In this version all the catalogue's models are available except models: Linos, Solid, Volume.

In case modular door usage there is no possibility of making ventilation undercut.

Attention!

System can be fitted only in at least 125mm wall.

EXTRA CHARGE OPTIONS

steel oval, round silver or golden handles 2 pieces

hook lock with set of oval or round handles
in versions Room/Toilet in golden or chrome

symmetric-system that allows to slide doors on both directions at the same time

retarder

INCLUDED IN SET

- aluminium cassette with installation kit
- masking shield in colour matched to the door

	Width	Height	C	D	E	F	G	H	H1
60	644	2040	1280	620	604	640	640	2020	2120
70	744		1480	720	704	740	740		
80	844		1680	820	804	840	840		
90	944		1880	920	904	940	940		
2x60	2x60		2480	620	1180	1220	640		
2x70	2x70		2880	720	1380	1420	740		
2x80	2x80		3280	820	1580	1620	840		
2x80	2x90		2680	920	1780	1820	940		



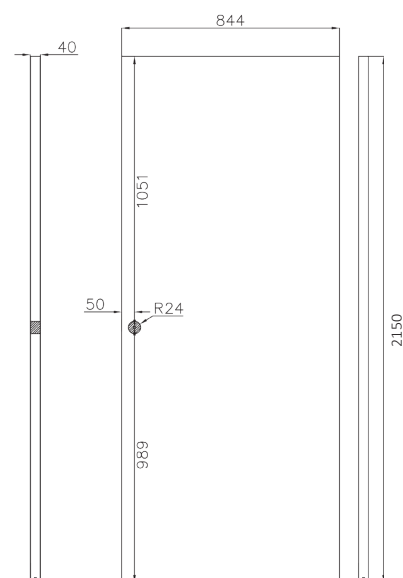

DESIGNATION

Design line systems are inspired by loft-vintage style. Exposing mechanics of the elements along with dark colours gives interior extraordinary industrial character.

Design line system only available in set with Loft nonrebated door in Top Decor colour.

Following sizes are available:

- singular system: „60“, „70“, „80“, „90“, „100“
- double-door system „2x60“, „2x70“, „2x80“, „2x90“.

Advantages of the system:

- silent and smooth sliding thanks to ball-bearing rollers
- easy installation, ability to position the door freely
- lacquer layer covering rail and all of system's elements has high mechanical damage resistance and prevents dust accumulation.

TECHNICAL DATA

- maximum door weight- 100 kg
- maximum door width „100“
- door thickness 35-45 mm
- door height 2150 mm
- rail length 2000 mm for doors 60-80 cm
- rail length 2500 mm for doors 90-100 cm
- black matt coating for decorative clinches and corners
- wall drilling height at 2080 mm

INCLUDED IN SET

Blockade, buckle, fence, stopper, rail and tube

EXTRA CHARGE OPTIONS

1. Silent-Stop two elemented closing system
2. Inserted rectangle handle 203x53mm, black matt
3. Trapeze convex handle 255x32mm, black matt
4. Bottom rail installed on wall. Installation doesn't require drilling additional holes in the wall
5. On-wall buckle designed for installation of second rail in cas of double-door system
6. Decorative clinches and corners for doors (per piece)





PURPOSE

The use of Sara Pro door frame allows placing the leaf in one plane with the wall line. Frame remains as an invisible element. This solution allows to „hide” the door in a wall which gives the possibility of painting it with the same paint as the walls or wallpaper.

INCLUDED IN SET

- Sara Pro door frame with a paintable door leaf 60-100 cm
- seal
- installation kit
- 2 Istar 505 hinges and a strike plate under the magnetic lock

TECHNICAL DATA

- dimensions- the width of the door frame

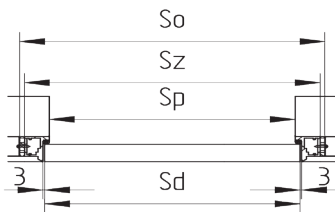

Leaf width Sd	644	744	844	944	1044
Construction opening width So	724	824	924	1024	1124
External width of the frame Sz	714	814	914	1014	1114
Passage width Sp	629	729	829	929	1029

TECHNICAL DATA

- dimensions- the width of the door frame

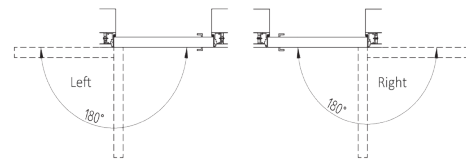

TECHNICAL DATA

- dimensions- door frame height

Leaf height Hd (mm)	2030
Construction opening height Ho (mm)	2079
External height of the frame Hz (mm)	2072
Passage height Hp (mm)	2030

TECHNICAL DATA

- plasterboard or concrete wall applications

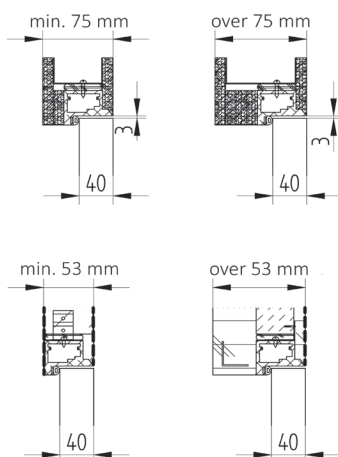

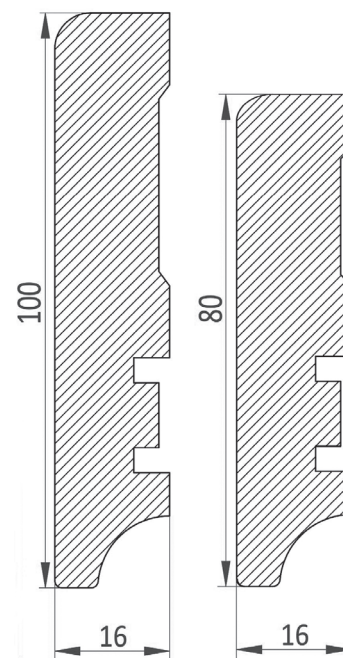
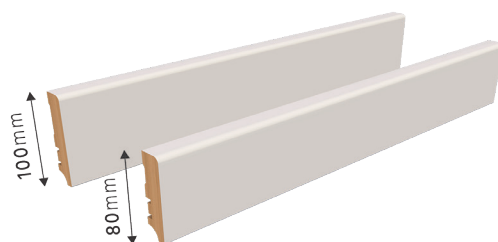
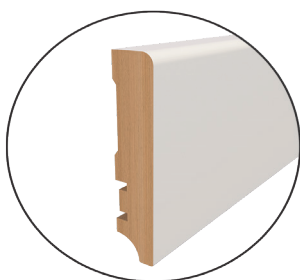

Profile	Colours
80x16x2100	Top Decor
80x16x2100	CPL
100x16x2100	Top Decor
100x16x2100	CPL

TECHNICAL DATA

- length of a single strip 2,1 m
- available in all colours from the catalogue
- the given prices are for one piece of the skirting board
- clamp-free assembly with an adhesive
- self-trimming angles

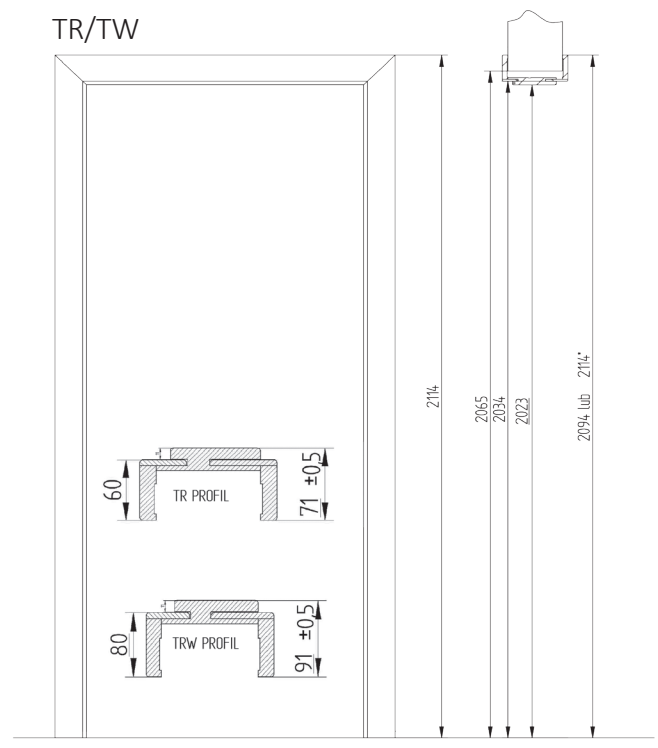
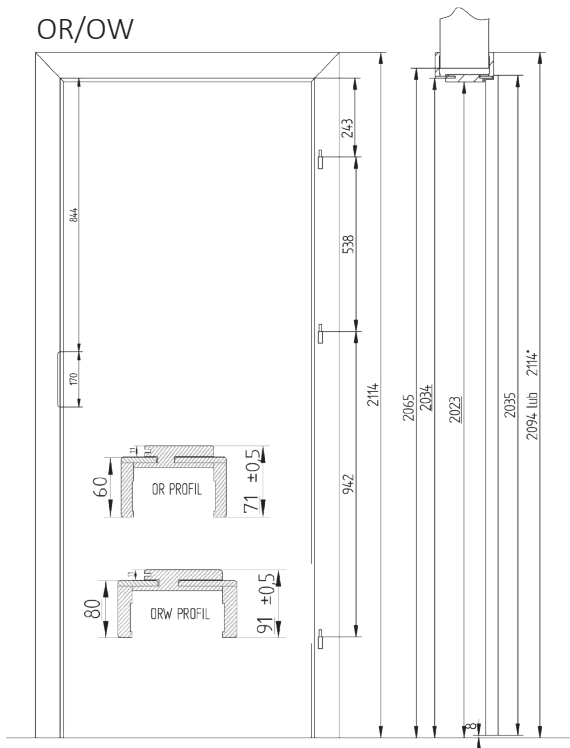

DESIGNATION

Adjustable door frame provides much more construction and arrangement possibilities than a fixed door frame. Different adjustment ranges allow to install the frame on a 80mm to 500mm thick wall.

Architraves for adjustable frames grant the ability to cover the wall from two sides, thus giving much better final result.

Adjustable tunnel is an ideal solution for finishing a construction door openings. It is recommended to enclose the wall with an adjustable tunnel when buying on-wall systems.

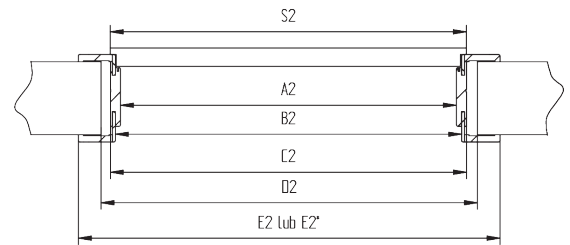

INCLUDED IN SET

- set of vertical base elements
- upper beam
- seal in colour matched to the frame
- installation kit with three hinges

EXTRA CHARGE OPTIONS

- double frame +30% surcharge
- „100” and wider sized upper beam +30% surcharge
- enhanced adjustable frame surcharge

OR/OW	TR/TW	Range	Panels amount
OR/W 1	TR/W 1	80-100	1
OR/W 2	TR/W 2	100-140	1
OR/W 3	TR/W 3	140-180	1
OR/W 4	TR/W 4	180-220	1
OR/W 5	TR/W 5	220-260	1
OR/W 6	TR/W 6	260-300	1
OR/W 7	TR/W 7	300-340	2
OR/W 8	TR/W 8	340-380	2
OR/W 9	TR/W 9	380-420	2
OR/W 10	TR/W 10	420-460	3
OR/W 11	TR/W 11	460-500	3

	DOUBLE FRAMES																			
	60	70	80	90	100	60+40	2x60	60+70	60+80	60+90	70+40	2x70	70+80	70+90	80+40	2x80	80+90	90+40	2x90	
S2	644	744	844	944	1044	644+444	2x644	644+744	644+844	644+944	744+444	2x744	744+844	744+944	844+444	2x844	844+944	944+444	2x944	
A2	602	702	802	902	1002	1050	1250	1350	1450	1550	1150	1450	1550	1650	1250	1650	1750	1350	1850	
B2	624	724	824	924	1024	1072	1272	1372	1472	1572	1172	1472	1572	1672	1272	1672	1772	1372	1872	
C2	646	746	846	946	1046	1094	1294	1394	1494	1594	1194	1494	1594	1694	1294	1694	1794	1394	1894	
D2	680	780	880	980	1080	1135	1335	1435	1535	1635	1235	1535	1635	1735	1335	1735	1835	1435	1935	
E2	744	844	944	1044	1144	1192	1392	1492	1592	1692	1292	1592	1692	1792	1392	1792	1892	1492	1992	
E2*	784	884	984	1084	1184	1232	1432	1532	1632	1732	1332	1632	1732	1832	1432	1832	1932	1532	2032	



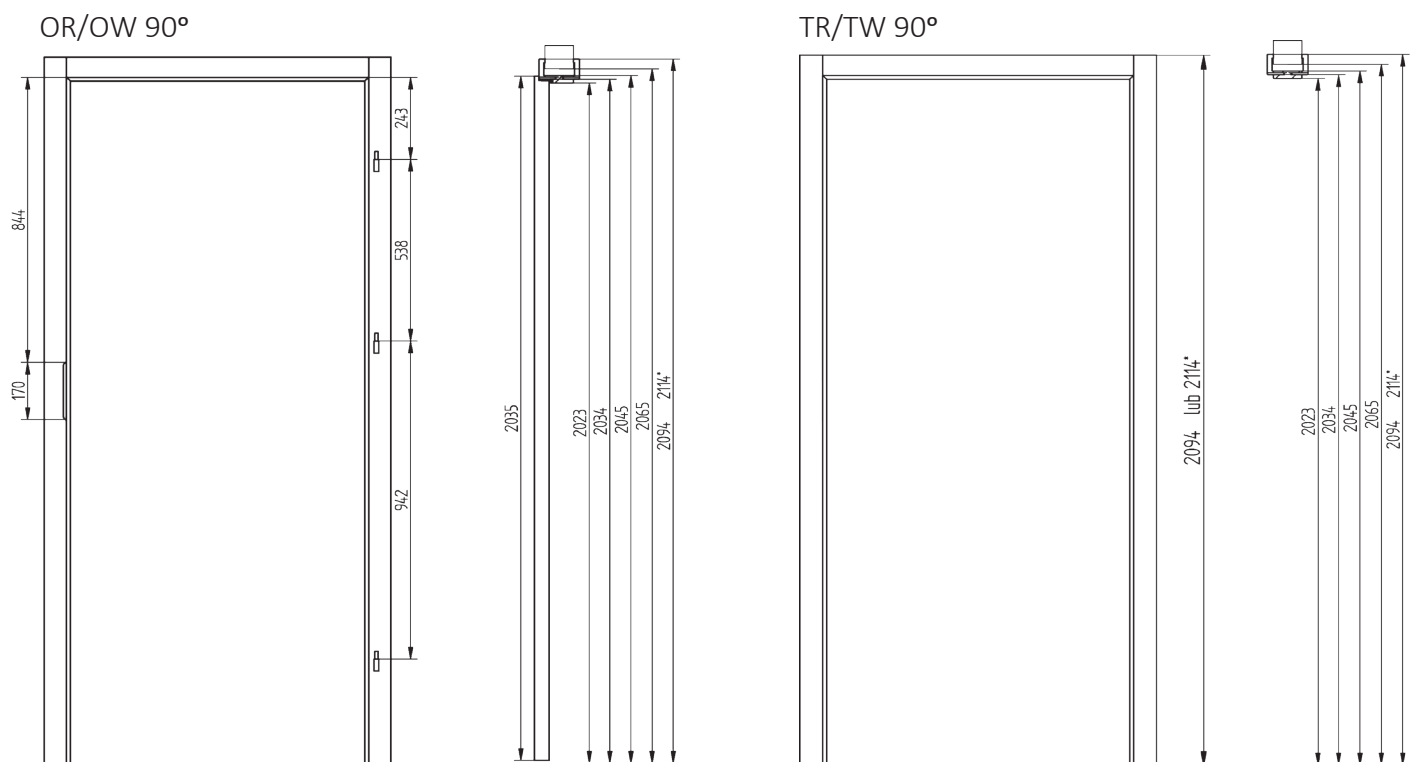

DESIGNATION

Adjustable door frame provides much more construction and arrangement possibilities than a fixed door frame. Different adjustment ranges allow to install the frame on a 80mm to 500mm thick wall.

Architraves for adjustable frames grant the ability to cover the wall from two sides, thus giving much better final result.

Adjustable tunnel is an ideal solution for finishing a construction door openings. It is recommended to enclose the wall with an adjustable tunnel when buying on-wall systems.

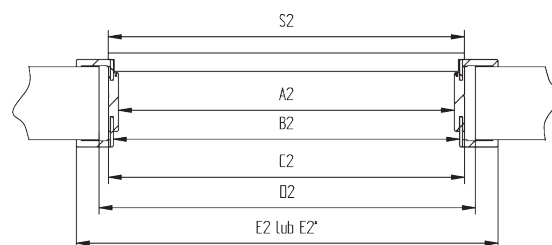

INCLUDED IN SET

- set of vertical base elements
- upper beam
- seal in colour matched to the frame
- installation kit with three hinges

EXTRA CHARGE OPTIONS

- double frame +30% surcharge
- „100” and wider sized upper beam +30% surcharge

OR/OW	TR/TW	Range	Panels amount
OR/W 1	TR/W 1	80-100	1
OR/W 2	TR/W 2	100-140	1
OR/W 3	TR/W 3	140-180	1
OR/W 4	TR/W 4	180-220	1
OR/W 5	TR/W 5	220-260	1
OR/W 6	TR/W 6	260-300	1
OR/W 7	TR/W 7	300-340	2
OR/W 8	TR/W 8	340-380	2
OR/W 9	TR/W 9	380-420	2
OR/W 10	TR/W 10	420-460	3
OR/W 11	TR/W 11	460-500	3

DOUBLE FRAMES																			
	60	70	80	90	100	60+40	2x60	60+70	60+80	60+90	70+40	2x70	70+80	70+90	80+40	2x80	80+90	90+40	2x90
S2	602	702	802	902	1002	1050	1250	1350	1450	1550	1150	1450	1550	1650	1250	1650	1750	1350	1850
A2	624	724	824	924	1024	1072	1272	1372	1472	1572	1172	1472	1572	1672	1272	1672	1772	1372	1872
B2	646	746	846	946	1046	1094	1294	1394	1494	1594	1194	1494	1594	1694	1294	1694	1794	1394	1894
C2	680	780	880	980	1080	1135	1335	1435	1535	1635	1235	1535	1635	1735	1335	1735	1835	1435	1935
D2	744	844	944	1044	1144	1192	1392	1492	1592	1692	1292	1592	1692	1792	1392	1792	1892	1492	1992
E2	784	884	984	1084	1184	1232	1432	1532	1632	1732	1332	1632	1732	1832	1432	1832	1932	1532	2032
E2*	784	884	984	1084	1184	1232	1432	1532	1632	1732	1332	1632	1732	1832	1432	1832	1932	1532	2032

Nonrebated frame 45°

ORB

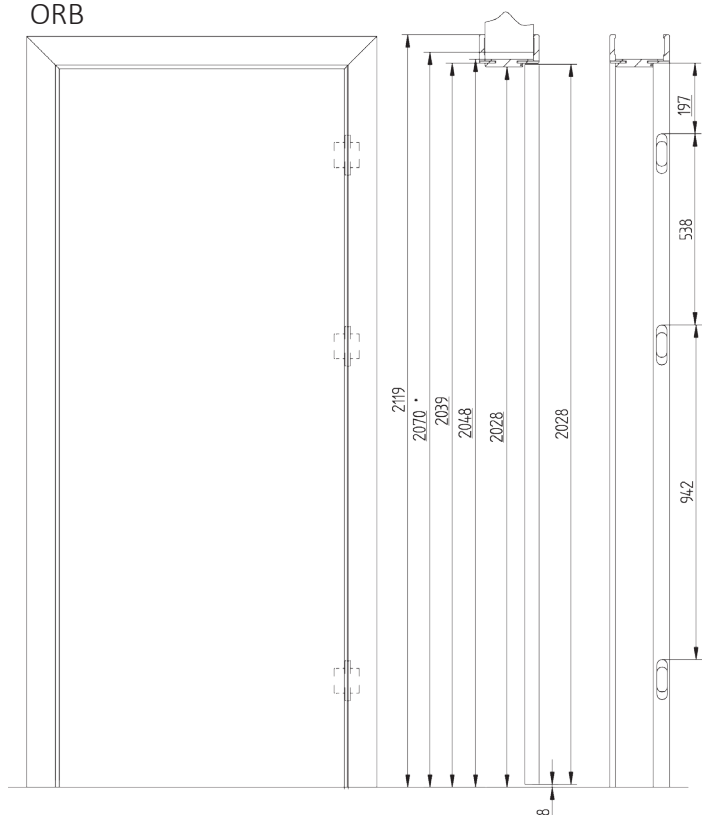

45° angle architrave

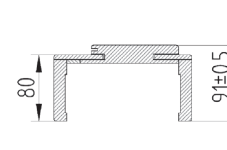

Door frames

60	70	80	90	100	
618	718	818	918	1018	S2
602	702	802	902	1002	A2
624	724	824	924	1024	B2
646	746	846	946	1046	C2
680	780	880	980	1080	D2
784	884	984	1084	1184	E2

DESIGNATION

Adjustable nonrebated door frames are dedicated for installation with nonrebated door leaves. Frame core is made of 22mm thick MDF board. Usage of an ORB door frame type makes door hinges invisible as well as flush finish for the door and a frame. A flat angle architraves make the face and adjustable part of the frame. Different adjustment ranges allow to install the frame on the 96mm to 516mm thick wall.

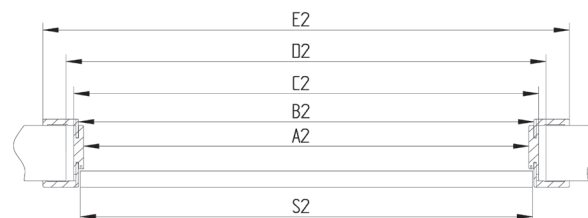

INCLUDED IN SET

- set of vertical base elements
- upper beam
- seal in colour matched to the frame
- installation kit with three hinges

EXTRA CHARGE OPTIONS

- „100” and wider sized upper beam +30% surcharge

ORB	Range	Panels amount
ORB 1	96-116	1
ORB 2	116-156	1
ORB 3	156-196	1
ORB 4	196-236	1
ORB 5	236-276	1
ORB 6	276-316	2
ORB 7	316-356	2
ORB 8	356-496	2
ORB 9	396-436	2
ORB 10	436-476	3
ORB 11	476-516	3



ORB 90°

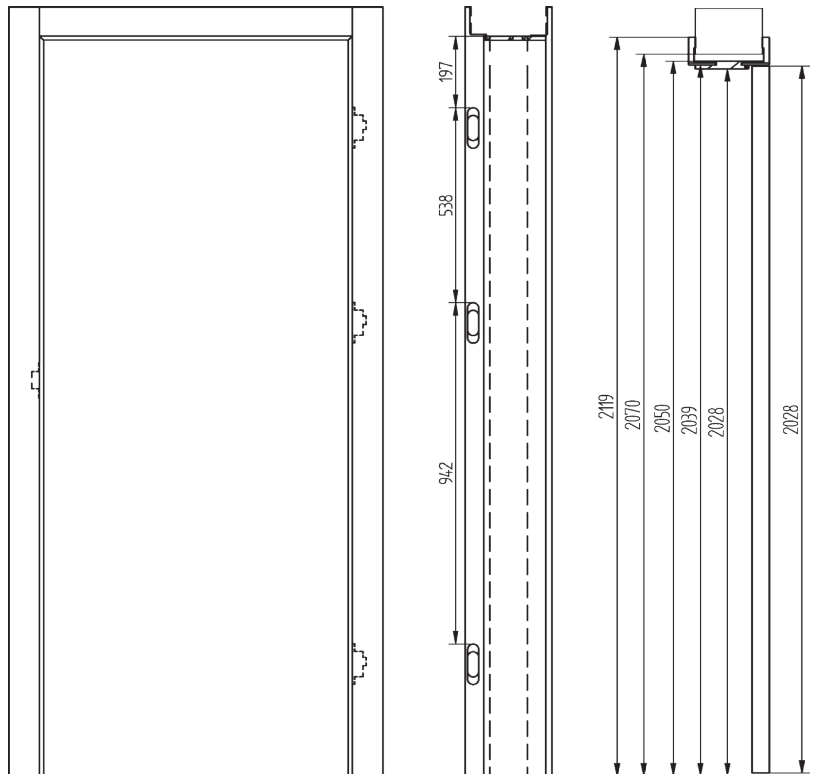

90° angle architrave

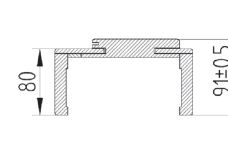

60	70	80	90	100	
618	718	818	918	1018	S2
602	702	802	902	1002	A2
624	724	824	924	1024	B2
646	746	846	946	1046	C2
680	780	880	980	1080	D2
784	884	984	1084	1184	E2

DESIGNATION

Adjustable nonrebated door frames are dedicated for installation with nonrebated door leaves. Frame core is made of 22mm thick MDF board. Usage of an ORB door frame type makes door hinges invisible as well as flush finish for the door and a frame. A flat angle architraves make the face and adjustable part of the frame. Different adjustment ranges allow to install the frame on the 96mm to 516mm thick wall.

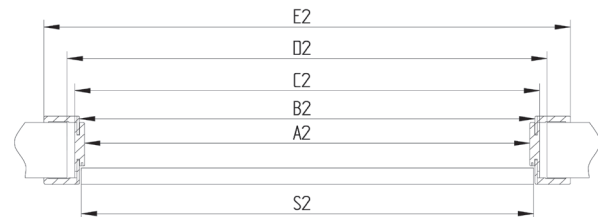

INCLUDED IN SET

- set of vertical base elements
- upper beam
- seal in colour matched to the frame
- installation kit with three hinges

EXTRA CHARGE OPTIONS

- „100” and wider sized upper beam +30% surcharge

ORB	Range	Panels amount
ORB 1	96-116	1
ORB 2	116-156	1
ORB 3	156-196	1
ORB 4	196-236	1
ORB 5	236-276	1
ORB 6	276-316	2
ORB 7	316-356	2
ORB 8	356-496	2
ORB 9	396-436	2
ORB 10	436-476	3
ORB 11	476-516	3

Soft edge fixed frame

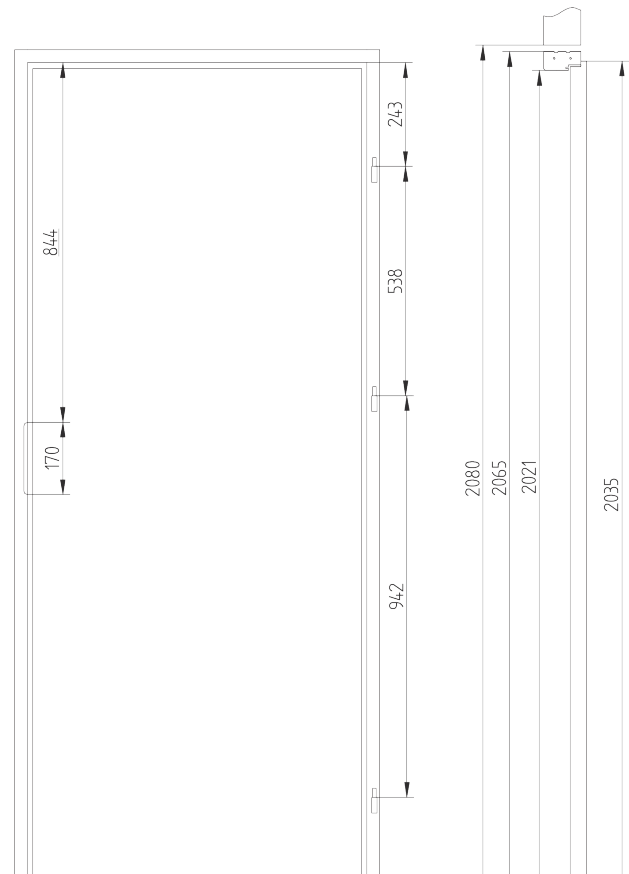

CONSTRUCTION

Fixed frame is made of solid 44mm MDF board. Wrapped with TOP-DECOR, ECOLINE or CPL foil. It has a fixed 90mm width and is available with 3 hinges option. Flat masking trim and a quarterround can be fitted to make the fixed frame look more aesthetic.

INCLUDED IN SET

- set of vertical base elements
- upper beam
- seal in colour matched to the frame
- installation kit with two or three hinges

EXTRA CHARGE OPTIONS

- double frame +30% surcharge
- „100” and wider sized upper beam +30% surcharge

USE

Fixed soft frame is recommended for all the internal rebated door models except for „Solid Pro” and „Volume”.

Dimensions of fixed frames (OS)

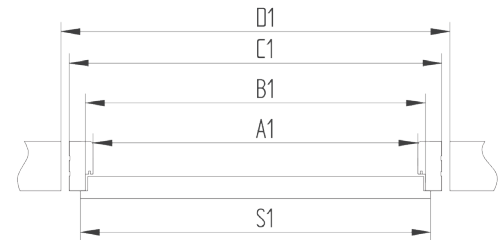

Quarterround

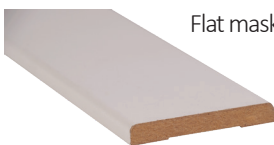

Flat masking trim

DOUBLE FRAMES

	60	70	80	90	100	60+40	2x60	60+70	60+80	60+90	70+40	2x70	70+80	70+90	80+40	2x80	80+90	90+40	2x90
S1	644	744	844	944	1044	644+444	2x644	644+744	644+844	644+944	744+444	2x744	744+844	744+944	844+444	2x844	844+944	944+444	2x944
A1	598	698	798	898	998	1046	1246	1346	1446	1546	1146	1446	1546	1644	12-46	1646	1746	1346	1846
B1	625	725	825	925	1025	1073	1273	1373	1473	1573	1173	1473	1573	1673	1273	1673	1773	1373	1873
C1	687	787	887	987	1087	1135	1335	1435	1535	1635	1235	1535	1635	1735	1335	1735	1835	1435	1935
D1	711	811	911	1011	1111	1161	1361	1461	1561	1661	1261	1561	1661	1761	1361	1761	1861	1461	1961





Overlay frame adjustment range (ON) and overlay tunnel frame (TN)

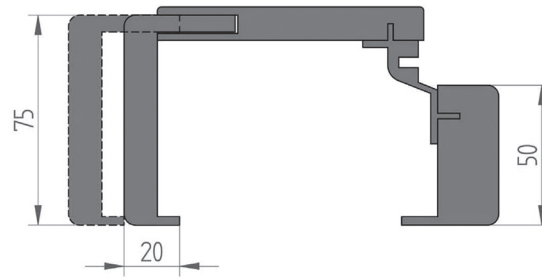

DESIGNATION

Overlay frame is a modern solution that allows to change metal frame without necessity to remove old elements nor the need to drill the wall. It is a solution that provides good outcomes and makes interior look more attractive with minimal amount of work required. Frame allows to change door opening direction.

INCLUDED IN SET

- set of vertical base elements
- upper beam
- seal in colour matched to the frame
- installation kit with hinges

EXTRA CHARGE OPTIONS

- „100” and wider sized upper beam +30% surcharge

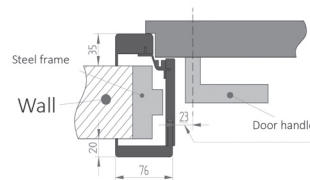

Distance from handle axis to the edge of the overlay frame core.

Attention!

Check width of the covers before buying handles to prevent collision while closing the door.

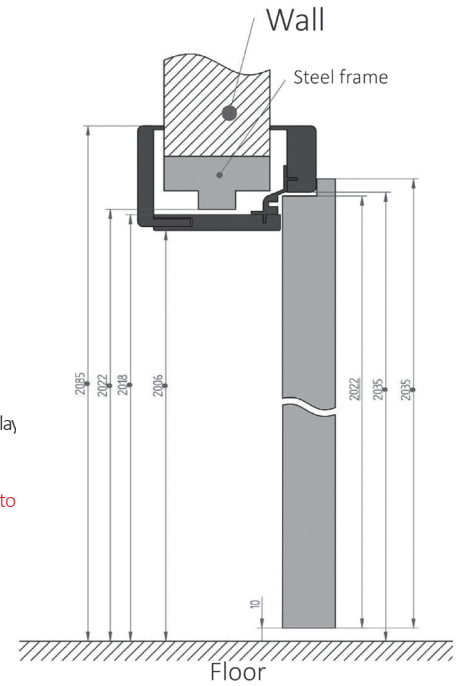

Dimensions of frames/tunnels (ON)/(TN)

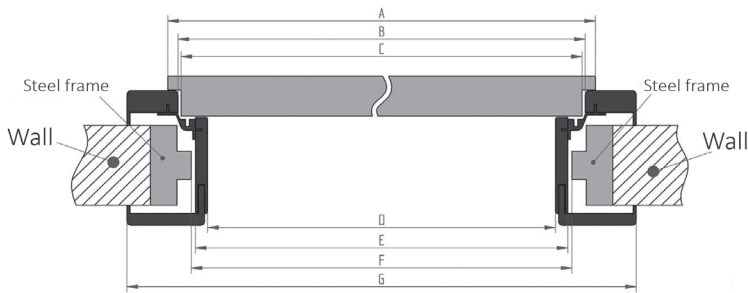

Door width	A	B	C	D	E	F	G
60	644	624	618	566	590	598	724
70	744	724	718	666	690	698	824
80	844	824	818	766	790	798	924
90	944	924	918	866	890	898	1024
100	1044	1024	1018	966	990	998	1124

F- minimal dimension of space in steel frame necessary to install overlay frame

OR/OW	Range	Panels amount
ON 1	80-100	1
ON 2	100-120	1
ON 3	120-140	1
ON 4	140-160	1
ON 5	160-180	1
ON 6	180-200	1
ON 7	200-220	1
ON 8	220-240	2
ON 9	240-260	2
ON 10	260-280	2
ON 11	280-300	2
ON 12	300-320	2
ON 13	320-340	2
ON 14	340-360	2
ON 15	360-380	3
ON 16	380-400	3
ON 17	400-420	3

DOOR DIMENTIONS - POLISH DIN STANDARD

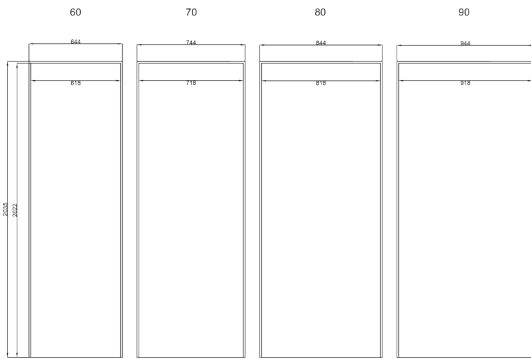

DOOR DIMENTIONS - CZECH ČSN STANDARD

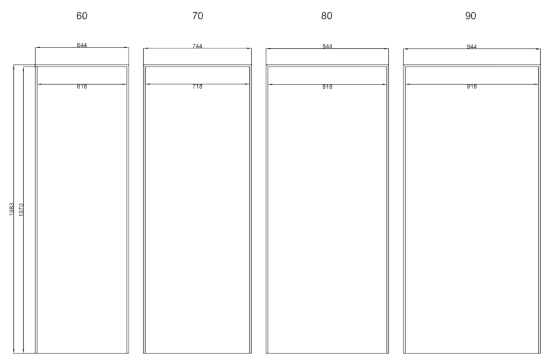

NONREBATED DOOR DIMENTIONS

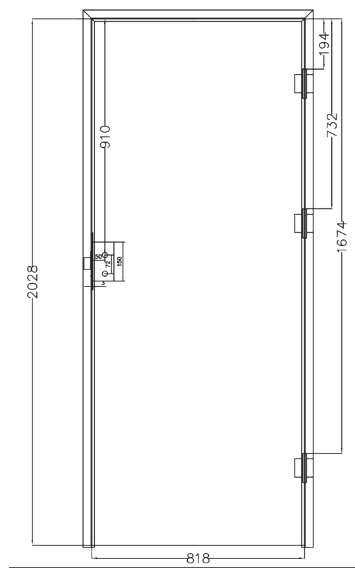

SLIDING DOOR SYSTEM - LEAF DIMENTIONS

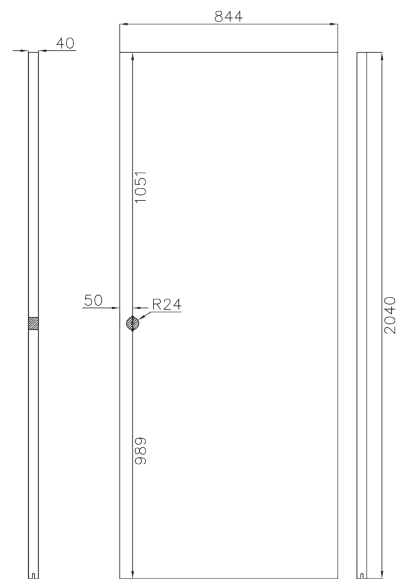

DOOR OPENING DIRECTION

Right door leaf

Left door leaf



DOUBLE-DOOR SYSTEM DIRECTION

Left double-door

Right double-door



Top-Decor



Sonoma	Truffle / Trufla	Spring Oak / Dąb Wiosenny	Japan Wenge / Wenge Japońskie
Rustical Walnut / Orzech Rustykalny	Gotland Oak / Dąb Gotlandzki	White / Biały	Black / Czarny
Grey Oak / Dąb Szary	Siberian Oak / Dąb Syberyjski	Scandic	Sanmarino Walnut / Orzech Sanmarino

Laminat CPL



Ash Modern / Jesion Modern	Modern Oak / Dąb Modern	Wenge Modern	Modern White / Biały Modern
Classic Oak / Dąb Klasyk	Modern Walnut / Orzech Modern	NEW! Walnut / Orzech Włoski	NEW! Water Oak / Dąb Wodny

Ecoline



Oak Eco / Dąb Eco	Bleached Oak Eco / Dąb Bielony Eco	Graphite Eco / Grafit Eco	NEW! Grey Premium Matt / Szary Premium Mat
NEW! Grey Super Matt / Szary Super Mat	NEW! Beige Pro / Beż Pro	NEW! Navy Pro / Granat Pro	NEW! Smoked Walnut / Orzech palony

Colours presented in the catalogue can differ. Always compare colours with provided colour samples. The manufacturer reserves the right to change prices and availability of the goods without notice.

PerfectDoor Sp. z o. o.
ul. Fabryczna 1
27-415 Kunów
 +48 41 261 15 77
biuro@perfectdoor.pl